

Ann. Rev. Ecol. Syst. 1987. 18:489-522
Copyright © 1987 by Annual Reviews Inc. All rights reserved

INTRASPECIFIC PHYLOGEOGRAPHY: The Mitochondrial DNA Bridge Between Population Genetics and Systematics

John C. Avise¹, Jonathan Arnold¹, R. Martin Ball¹, Eldredge Bermingham^{1,2}, Trip Lamb^{1,3}, Joseph E. Neigel^{1,4}, Carol A. Reeb¹, and Nancy C. Saunders^{1,5}

¹Department of Genetics, University of Georgia, Athens, Georgia 30602; ²NMFS/CZES, Genetics, 2725 Montlake Boulevard East, Seattle, Washington 98112; ³Savannah River Ecology Laboratory, Drawer E, Aiken, South Carolina 29801; ⁴Department of Microbiology and Immunology, School of Medicine, University of California, Los Angeles, California 90024; ⁵School of Veterinary Medicine, Virginia Tech University, Blacksburg, Virginia 24046

INTRODUCTION

A recurring debate in evolutionary biology is over the extent to which microevolutionary processes operating within species can be extrapolated to explain macroevolutionary differences among species and higher taxa (36, 38, 45, 46, 53, 67, 68, 80). As discussed by Stebbins & Ayala (83), several issues involved must be carefully distinguished, such as (a) whether microevolutionary processes (e.g. mutation, chromosomal change, genetic drift, natural selection) have operated throughout the history of life (presumably they have); (b) whether such known processes can by themselves *account* for macroevolutionary phenomena; and (c) whether these processes can *predict* macroevolutionary trends and patterns. In another, phylogenetic sense,

macroevolution is ineluctably an extrapolation of microevolution: Organisms have parents, who in turn had parents, and so on back through time. Thus, the branches in macroevolutionary trees have a substructure that consists of smaller branches and twigs, ultimately resolved as generation-to-generation pedigrees (Figure 1). It is through these pedigrees that genes have been transmitted, tracing the stream of heredity that is phylogeny.

It would seem that considerations of phylogeny and heredity should provide a logical starting point for attempts to understand any connections of macroevolution to microevolution. Yet amazingly, the discipline traditionally associated with heredity and microevolutionary process (population genetics) developed and has remained largely separate from those fields associated with phylogeny and macroevolution (systematics and paleontology). Thus, several classic textbooks in population genetics (35, 39, 64) do not so much as index "phylogeny," "systematics," or "speciation," while the equally important textbooks in systematics (55, 81, 96) can be read and understood with only the most rudimentary knowledge of Mendelian and population genetics. Notwithstanding some evidence for recent increased communication between these disciplines (40, 71), too many systematists and population geneticists continue to operate in largely separate realms, employing different languages and concepts to address issues that should be of importance to all.

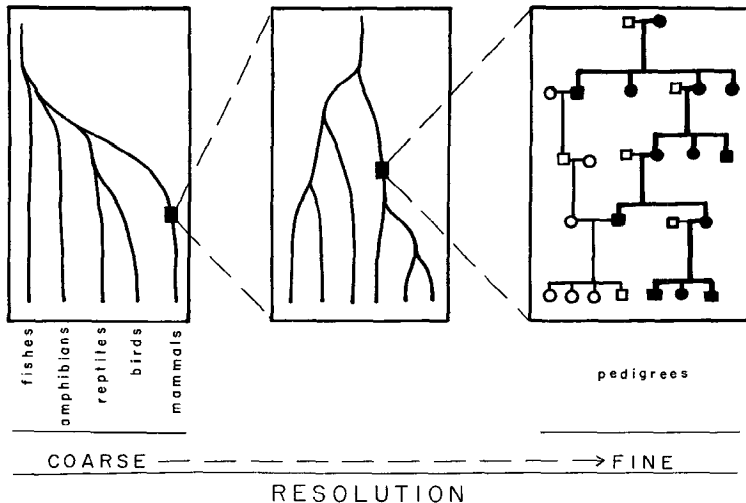

Figure 1 At closer levels of examination, macroevolutionary trees (such as the one on the left summarizing relationships among some of the vertebrate classes) must in principle have a substructure consisting of smaller and smaller branches, ultimately resolvable as family pedigrees through which genes have been transmitted. Some branches in the pedigree on the right have been darkened to indicate the transmission path of mtDNA from the earliest pictured female.

It might also be supposed that the newer field of molecular evolution, with its obvious grounding in genetics and yet a concern with phylogeny, would have facilitated a firmer linkage between micro- and macroevolutionary study. And to some extent it has, by allowing evaluations of large-scale evolutionary trees in terms of DNA and protein characters with a known genetic basis. But movement in the opposite direction—extending phylogenetic principles and reasoning to the microevolutionary level—has been negligible. Thus, when molecular evolutionists work at the intraspecific level, they tend to adopt the terms and concepts of population genetics, such as “variances in allele frequencies,” “genetic drift,” “mutation-selection balance,” “fitness,” and so forth, but not the terms and concepts of systematics, such as “monophyletic groups,” “parsimony networks,” “clades,” or “synapomorphic character states.” Conversely, when systematists work at the intraspecific level, for example to describe subspecies, it is usually with morphological or behavioral traits whose genetic basis (or even control) is poorly known. Worse yet, geographic locale per se is too often the primary basis for assigning newly collected specimens to “subspecies,” so that attempts to understand any relationship between phylogenetic differentiation and spatial separation flirt with circular reasoning.

The reasons that the field of molecular evolution has not contributed greatly to the incorporation of phylogenetic principles into population genetics are, we suspect, primarily twofold. First, the inception and early development of molecular evolution (reviewed in 18, 63, 70) largely coincided with (and stimulated) the rise of the neutralist school of thought (58, 59), which challenged a common view that genetic variability was molded primarily by natural selection. Thus, molecular evolutionists were (justifiably) preoccupied with the selectionist-neutralist debate and never gained very close contact with various schools of systematic thought that were also growing actively at that time (55, 81). Second, in the early years protein electrophoresis was the only molecular technique readily applicable to comparisons at the intraspecific level. Yet allozymes of a particular locus are qualitative, multistate traits the phylogenetic order of which cannot be safely inferred from the observable property, electrophoretic mobility. Furthermore, allozymes are encoded by nuclear genes that segregate and recombine during each generation of sexual reproduction. These attributes of allozymes understandably directed methods of data analysis toward concerns with allele frequencies and heterozygosities, which in turn channeled thinking back into the traditional framework and language of population genetics and away from phylogeny.

The purpose of this report is to make a case that animal mitochondrial DNA (mtDNA) (by virtue of its maternal, nonrecombining mode of inheritance, rapid pace of evolution, and extensive intraspecific polymorphism) permits and even demands an extension of phylogenetic thinking to the microevolu-

tionary level. As such, data from mtDNA can provide a liaison service for expanding communication between systematists and population geneticists. With empirical and conceptual channels opened, it might then be possible to reconsider various connections between micro- and macroevolutionary change as interpreted against a continuous genealogical backdrop. This review will be a success if it stimulates further dialogue in these areas.

MTDNA—NOT “JUST ANOTHER” MOLECULAR MARKER

If one were to specify the properties desired of an ideal molecular system for phylogenetic analysis, the wish list might include the following. The molecule should: (a) be distinctive, yet ubiquitously distributed, so that secure homologous comparisons could be made among a wide variety of organisms; (b) be easy to isolate and assay; (c) have a simple genetic structure lacking complicating features such as repetitive DNA, transposable elements, pseudogenes, and introns; (d) exhibit a straightforward mode of genetic transmission, without recombination or other genetic rearrangements; (e) provide suites of qualitative character states whose phylogenetic interrelationships could be inferred by reasonable parsimony criteria; and, for purposes of microevolutionary analysis, (f) evolve at a rapid pace such that new character states commonly arise within the lifespan of a species. To a remarkable degree, the mitochondrial DNA of higher animals meets all of the above criteria.

Molecular properties of animal mtDNA have been reviewed previously (10, 25, 26), so only a brief synopsis sufficient for current discussion is given here. The reader is directed to the earlier papers for details and qualifications. In higher animals, mtDNA is a small, covalently closed circular molecule, about 16–20 kilobases long. It is tightly packed with genes for 13 messenger RNA's, 2 ribosomal RNA's, and 22 transfer RNA's. In addition to these 37 genes, an area known as the “D-loop” (in vertebrates and echinoderms) or “A + T-rich” region (in *Drosophila*), roughly 0.8 kilobases long, appears to exercise control over mtDNA replication and RNA transcription. Introns, repetitive DNA, pseudogenes, and even sizeable spacer sequences between genes, are all absent. Gene arrangement appears very stable, at least within a taxonomic class or phylum. For example, gene order is identical in assayed mammals and frogs but differs from that in *Drosophila*. Nonetheless, evolution at the nucleotide sequence level is rapid, perhaps 1–10 times faster than typical single-copy nuclear DNA (28, 92). Most of the genetic changes are simple base substitutions; some are small addition/deletions (one or a few nucleotides); and fewer still involve large length differences (up to several hundred nucleotides). The size differences are usually (though not ex-

clusively; 69) confined to the control region of the molecule, which in general is evolving especially rapidly. The final and perhaps most important point is that, to the best of current knowledge (50, 60), inheritance of animal mtDNA is strictly maternal. Thus, unlike the situation for nuclear DNA, the mtDNA mutations arising in different individuals are not recombined during sexual reproduction.

No molecular system is likely to be perfect for phylogenetic analysis, and mtDNA does have some potential and real limitations that need to be recognized:

Heteroplasmy

Most somatic cells (and mature oocytes) contain hundreds or thousands of mtDNA molecules, so that at its inception a new mutation will either generate or add to a heteroplasmic condition in which two or more genotypes coexist within an individual. On theoretical grounds, it was originally feared that heteroplasmy might be extensive and hopelessly complicate mtDNA study, but empirical experience proved this worry to be unjustified. Cases of heteroplasmy have been discovered (20 and references therein) but are unusual and therefore of little impact in routine surveys of animal mtDNA. Current thinking is that mutations within a cell line (as opposed to paternal leakage of mtDNA via sperm) generate most instances of heteroplasmy, and that the heteroplasmic state is quite transitory, due to rapid sorting of mtDNA molecules in germcell lineages (34, 52, 76, 86). Thus, as phrased by Wilson et al (97), "The vast majority of individuals tested seem effectively haploid as regards the number of types of mtDNA transmitted to the next generation (although polyploid as regards the number of mtDNA copies per cell)."

Homoplasmy

An ideal phylogenetic marker would be free from reversals as well as parallel or convergent evolutionary change (homoplasmy). In one respect, mtDNA falls short of this standard—many restriction sites have been observed to "blink" on and off repeatedly during evolution (e.g. 43, 61). This phenomenon is presumably most often attributable to recurrent transitional base substitutions (3) at some nucleotide sites. If particular positions in the mtDNA genome are considered "characters," and if evolutionary change at these positions has been especially rapid with respect to the time since separation of assayed lineages, then the small number of alternative character states assumable insures that some homoplasious changes will have occurred. Nonetheless, because mtDNA genomes are nonrecombining, the entire molecule can justifiably be considered the "character," in which case the number of possible character states becomes astronomical.

Typical empirical surveys of mtDNA (see beyond) effectively involve assay of at least several hundred base-pairs of information per individual. When viewed this way, any widespread and intricate similarities present in mtDNA are most unlikely to have arisen by convergent evolution, and so they must primarily reflect phylogenetic descent (or, conversely stated, any widespread and intricate differences observed among mtDNA molecules could not be overcome by wholesale convergent mutation). The effects of homoplasious change in mtDNA are thus probably limited to introduction of circumscribed ambiguity in tree or network placements of mtDNA genotypes. Furthermore, approaches for recognizing and treating homoplasy in mtDNA have been suggested (10, 89, 90).

Scale

Some nucleotide positions in mtDNA are far more labile evolutionarily than are others, presumably due to relaxed selective constraints (4). The initial rapid pace of mtDNA differentiation (estimated at about 2% sequence divergence per million years in mammals; 28) is attributable primarily to changes at these sites, after which further mtDNA differences accumulate much more slowly. The overall effect is that beyond perhaps about 8–10 million yr, a plot of mtDNA nucleotide sequence divergence (p) against time (t) becomes curvilinear, eventually reaching a plateau where estimation of t from p is pointless (28). For this reason, unless special precautions are taken to work only with more slowly evolving portions of the molecule, meaningful phylogenetic comparisons from conventional mtDNA surveys will normally be confined to conspecific populations and closely related species whose separations date to within the last few million years.

At the other end of the scale, for very recently disjoined populations or species, it is likely that a substantial fraction of observed mtDNA sequence differences arose prior to population separation (i.e. they represent retention of polymorphisms originally present in ancestral parental stock). There are at least two ways to deal with this potential complication. First, from a population genetic perspective, statistical corrections can be applied (72, 97). For example, let δ_X , δ_Y , δ_A , and δ_{XY} represent the mean pairwise mtDNA divergence values between individuals of population X, of population Y, of the ancestral population, and between individuals in population X versus Y, respectively. Although δ_A cannot be observed directly, it can be estimated by assuming that

$$\delta_A = 0.5 (\delta_X + \delta_Y).$$

Then the corrected distance estimate between populations X and Y becomes

$$\delta = \delta_{XY} - \delta_A.$$

A second way to deal with the predicament involves a shift to a phylogenetic perspective. Since mtDNA genotypes in different lines do not recombine, individual organisms (rather than populations or species) can justifiably be considered as the basic operational taxonomic units (OTU's) in a phylogenetic reconstruction (62). This straightforward approach, in which individuals (or, more precisely, their mtDNA genotypes) constitute the tips of hypothesized evolutionary trees (or nodes of evolutionary networks), can be especially informative. For example, with respect to matriarchal phylogeny, it is biologically quite plausible that some individuals may truly be more closely related to members of another species than they are to conspecifics, owing solely to particular patterns of maternal lineage survival and extinction accompanying the speciation process (73, 85; also see below).

Selection Versus Neutrality

The longstanding debate about whether the dynamics of genetic variation are governed primarily by natural selection or by genetic drift of neutral mutations, can also be extended to mtDNA. In our view, the phylogenetic value of mtDNA does not, however, completely hinge on the outcome. Thus, even if mtDNA genotypes prove commonly to differ with respect to fitness, properly identified synapomorphic (shared-derived) character states should still permit recognition of monophyletic assemblages (clades) of molecules. Nonetheless, in some kinds of data analyses involving genetic distance estimates and molecular clock concepts to date separation events, it would be especially important to know whether mtDNA variability is neutral (although, particularly when longer spans of time are involved and much genetic information is assayed, the magnitude of genetic differentiation under some models of natural selection should also be well-correlated with time; 9, 44).

Two senses in which mtDNA variability might be deemed neutral need to be carefully distinguished. First, in a mechanistic sense, we already "know" that most of the particular mtDNA genotypic variants segregating in populations probably have, by themselves, absolutely no differential effect on organismal fitness. These include, for example, base substitutions in silent positions of protein-coding genes, and some substitutions and small addition/deletions in the nontranscribed D-loop region. These changes are disproportionately common in mtDNA (25) and are ones for which only the most ardent selectionist would argue a direct link to organismal fitness. On the other hand, mtDNA contains genes whose products (usually in collaboration with those of the nuclear genome) are crucial to production of energy necessary for animal survival and reproduction (49, 74). Some mtDNA mutations must, then, be highly visible to selection. When they arise, each such mutation will by chance be associated with a particular array of mechanistically neutral variants elsewhere in the molecule. Since mtDNA is maternally

inherited, these associations will not be dissolved by recombination (95). In this second, dynamic sense, mechanistically neutral mtDNA variants may, through linkage to selected mtDNA mutations, have evolutionary histories that are at times influenced or even dominated by effects of natural selection. A deeper understanding of such possibilities poses a stiff challenge for future study. Not only will knowledge be required of the periodicity and intensity of selection on fitness-related mtDNA mutations, but historical accidents of association with neutral markers will have to be taken into account. Furthermore, all this action must be understood within the context of ever-changing nuclear gene backgrounds whose epistatic interactions with mtDNA are likely to be of great importance (5, 25, 49, 78).

Lineage Sampling Bias

The phylogenies inferred from mtDNA comparisons represent the presumed historical sequences of mutational events accompanying the differentiation of maternal lines. An mtDNA phylogeny is thus an example of a *molecular genealogy*—a record of evolutionary changes in a piece of DNA, in this case one that has a history of maternal transmission. In general, any *organismal phylogeny* must in some sense represent a composite attribute of many molecular genealogies, including those for all nuclear genes, each of which in any generation could have been transmitted through male or female parents. As phrased by Wainscoat (93), “We inherit our mitochondrial DNA from just one of our sixteen great-great grandparents, yet this maternal ancestor has only contributed one-sixteenth of our nuclear DNA.” The asexual, maternal transmission of mtDNA is thus a double-edged sword. Although the information recorded in mtDNA represents only one of many molecular tracings in the evolutionary histories of organisms, it is nonetheless a specified genealogical history (female → female → female), and one whose molecular record has not been complicated by the effects of recombination.

INTRASPECIFIC PHYLOGENY AND GEOGRAPHIC POPULATION STRUCTURE

Most mtDNA surveys of natural populations have involved the technically expedient restriction enzyme approach. MtDNA is isolated from individual animals, digested with particular endonucleases, and the resulting digestion products separated by molecular weight through gels. The “raw” data then consist of restriction fragment digestion profiles on gels, or with some additional effort, restriction site maps. The evolutionary changes in restriction sites underlying the differing digestion profiles or site maps can often be inferred simply, and a parsimony network summarizing the presumed history of genotypic interconversions can be generated. A straightforward example

involving *BstEII* sites observed in the mtDNA from *Peromyscus maniculatus* (61) is presented in Figure 2. A typical survey now often includes data from ten or more enzymes and involves, on average, 40–100 or more restriction sites per individual. The recognition sequence of each employed endonuclease is either four, five, or six base-pairs in length, so a routine survey of mtDNA would effectively screen individuals for genetic differences at several hundred nucleotide positions.

To exemplify more fully the kinds of phylogenetic implications inherent in such data, we briefly summarize results from a typical natural population survey. Bermingham & Avise (19) used 13 restriction endonucleases to score an average of 54 sites per individual in the mtDNA of 75 bowfin fish (*Amia calva*) collected from river drainages from South Carolina to Mississippi. A total of 13 distinct mtDNA genotypes (which for simplicity can be called “clones”) were observed. Figure 3A shows a hand-drawn parsimony network (constructed by an extension of the approach exemplified in Figure 2) interconnecting these clonal genotypes, and in Figure 3B this network is superimposed over the geographic sources of the collections. Two major genetic (and geographic) assemblages of mtDNA clones are apparent—an eastern assemblage of nine related clones observed in bowfin from South Carolina, Georgia, and Florida; and a western assemblage of four related

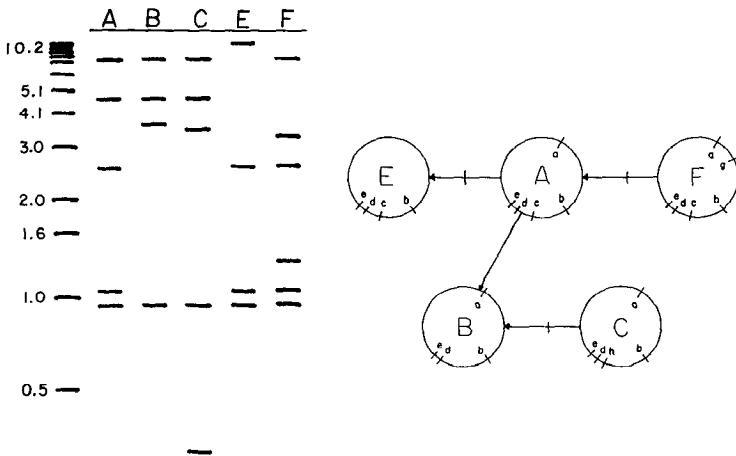

Figure 2 (left) Diagrammatic representation of the five *BstEII* digestion profiles observed among mtDNA's isolated from samples of *Peromyscus maniculatus* (61). The leftmost lane shows selected sizes (in kilobases) of fragments in a molecular weight standard. (right) Restriction site maps (obtained from double-digestion procedures) corresponding to the fragment profiles on the left. These site maps have been interconnected into a parsimony network reflecting probable evolutionary relationships among the *BstEII* patterns. Arrows indicate direction of site loss and not necessarily direction of evolution.

clones in bowfin from Alabama and Mississippi. *At least* four assayed restriction site changes distinguish any eastern from any western genotype.

As drawn, these parsimony networks are unrooted, but additional hypotheses about phylogenetic orientation can be advanced. By several criteria, mtDNA clone 1 is a likely candidate for the ancestral genotype within the eastern assemblage of *Amia calva*: (a) It is by far the most common eastern genotype, occurring in 30 of 59 assayed specimens; (b) it is geographically the most widespread, observed in nine of the ten eastern river drainages surveyed; and (c) in the parsimony analysis, it forms the hub of a network whose spokes connect separately to seven other mtDNA genotypes (Figure 3A). Clone 1 is also at least one mutation step closer to the western mtDNA

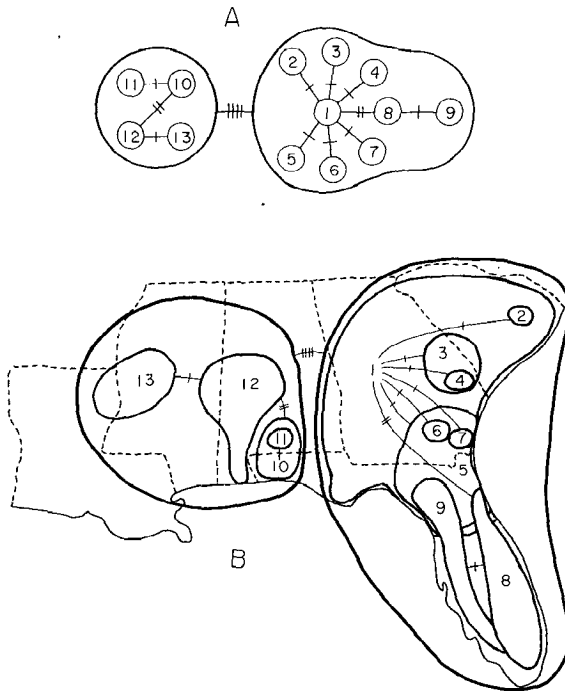
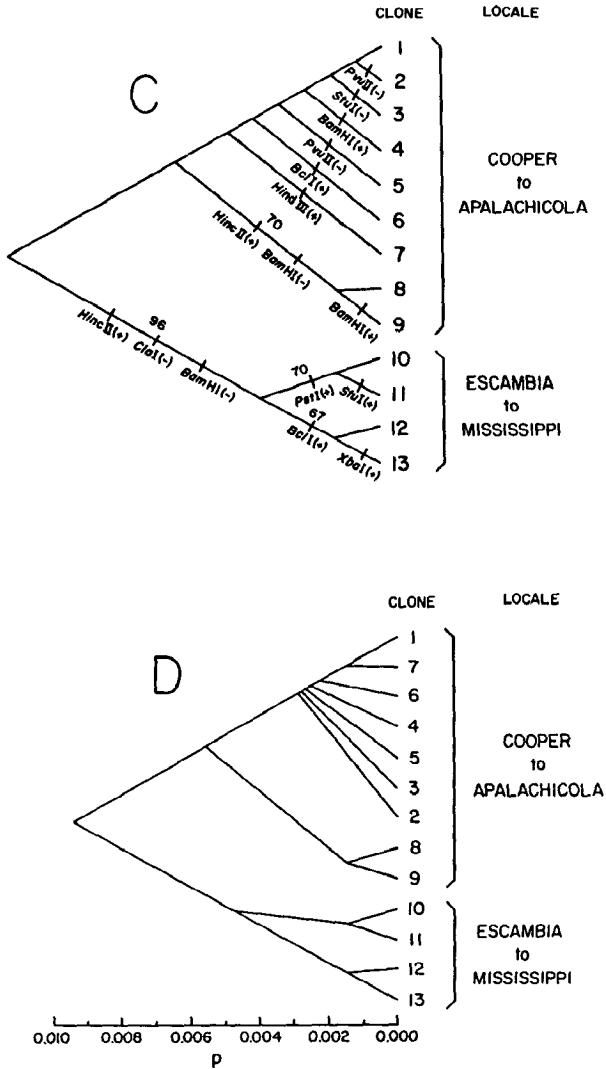

Figure 3 Phylogenetic networks and phenograms summarizing evolutionary relationships among 13 mtDNA genotypes observed in a sample of 75 bowfin fish, *Amia calva* (19). (A) Hand-drawn parsimony network. Slashes crossing branches indicate restriction site changes along a path; heavier lines encompass 2 major arrays of mtDNA genotypes distinguishable by at least 4 restriction site changes. (B) The parsimony network in A superimposed over the geographic sources of collections. (C) Wagner parsimony network computer generated from a presence-absence site matrix. Inferred restriction site changes are indicated, and numbers in the network represent levels of statistical support (by bootstrapping) for various clades. (D) UPGMA phenogram, where p is estimated nucleotide sequence divergence.



clade than are any other mtDNA genotypes in the east. In the western genotypic array, clones 10 and 12, which occur in the drainages most proximate to those in the east (Figure 3B), are genetically closest to clone 1 (each differs by four assayed mutation steps); and fish in the most westerly drainage show further distinction from these clones (Figures 3A and 3B).

Some data sets are far too large for such easy analysis by hand, and computer assistance is required. Several tree-building software packages are

available (42); we routinely employ various algorithms in the PHYLIP package distributed by Joe Felsenstein. For example, Figure 3C shows a Wagner parsimony network (from the METRO annealing algorithm in PHYLIP) of mtDNA genotypes in bowfin fish generated from a matrix consisting of presence-absence information for each restriction site in each mtDNA clone. Particular site changes along various branches of the network are shown, and numbers indicate the levels of statistical support (the proportion of times that a group was distinguished in a bootstrap analysis; 41) for a given hypothesized mtDNA clade.

It is also possible to convert mtDNA fragment or site data into estimates of nucleotide sequence divergence (p) between genotypes (e.g. 72, 91), and the resulting distance matrixes can provide the basis for tree or phenogram construction. Figure 3D shows a UPGMA phenogram (81) for the mtDNA clones in *Amia calva*. The eastern versus western clonal assemblages are again apparent and differ in nucleotide sequence by an average of about 1%. In general then, many qualitative and quantitative methods of tree construction can be applied to mtDNA data. It is beyond the scope of this review to address the ongoing debate about "best" methods for phylogeny reconstruction (and Avise's views have been presented elsewhere; 6). Suffice it to say that in our experience, tree-constructing algorithms involving philosophically distinct methodologies usually produce very similar outcomes when applied to a given set of mtDNA data. The pictured networks and phenograms for *Amia calva* (Figure 3) are merely a case in point.

In our laboratory, similar surveys of geographic variation in mtDNA have now been completed or are in progress for about 20 species, including mammals, birds, reptiles, amphibians, marine and freshwater fishes, and an invertebrate (the horseshoe crab). The remainder of this section summarizes major features of these data (Table 1) in the context of qualitative patterns of geographic population structure. The original papers should be consulted for details.

In principle, intraspecific phylogenies overlaid on geographic maps could yield many kinds of outcomes. Five major categories of possibilities and their provisional interpretations are summarized in Figure 4. For example, an mtDNA phylogeny itself could show discontinuities (or genetic "breaks") in which arrays of related genotypes differ from other such arrays by many mutational steps. Such genetically distinct mtDNA assemblages might occupy separate geographic regions within the range of a species (category I, Figure 4), or they could co-occur geographically (category II). Alternatively, mtDNA phylogenies themselves might be more or less continuous genetically, and spatially either disjunct (category III), totally overlapping (category IV), or nested (category V). We have empirical examples approximating almost all of these theoretical outcomes.

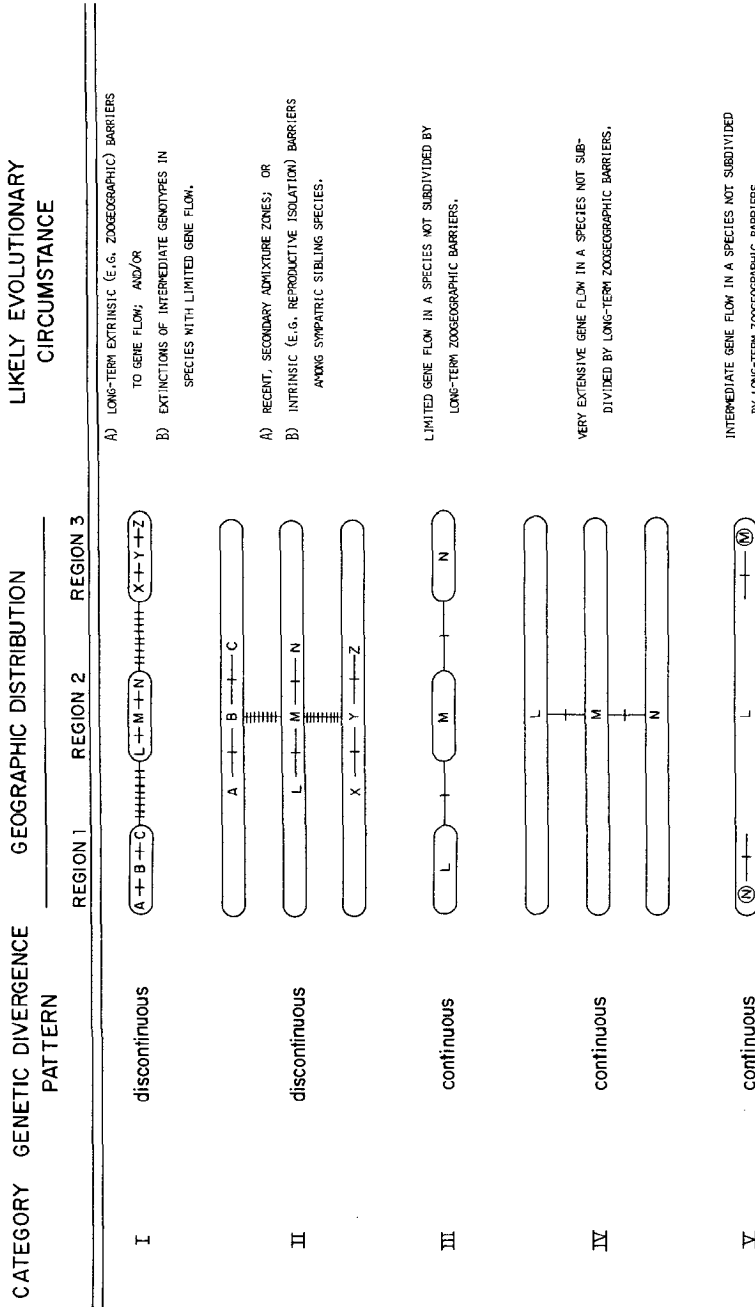

Figure 4 General phylogeographic patterns (relationships between phylogeny and geography) theoretically observable in mtDNA surveys (see text).

Category I—Phylogenetic Discontinuities, Spatial Separation

In our experience, this is the most commonly encountered situation. It applies for example, to the *Amia calva* case history already detailed above, in which arrays of related mtDNA genotypes occurred in eastern versus western river drainages in the southeastern United States, and the two arrays were differentiable by at least four assayed mutation steps (and $\bar{p} \cong 0.01$). The magnitudes of genetic breaks distinguishing populations from different geographic regions are in fact often considerably greater than that observed in *Amia calva*. For example, in the redear sunfish *Lepomis microlophus*, which was sampled from the same river drainages as *Amia*, eastern versus western arrays of mtDNA genotypes differed by 17 or more assayed mutation steps ($\bar{p} \cong 0.09$), yet *maximum* differentiation within either the eastern or western mtDNA assemblages was always less than $p = 0.007$ (19). Other species in which we have observed discontinuous intraspecific mtDNA phylogenetic networks, with a strong geographic orientation, include the pocket gopher (*Geomys pinetis*), deer mouse (*Peromyscus maniculatus*), bluegill sunfish (*Lepomis macrochirus*), spotted sunfish (*L. punctatus*), warmouth sunfish (*L. gulosus*), mudpuppy salamanders (*Necturus alabamensis* and relatives), desert tortoise (*Scaptochelys agassizii*), and horseshoe crab (*Limulus polyphemus*). References and relevant data from these studies are summarized in Table 1.

The most likely explanation for major genetic discontinuities that display geographic orientation involves long-term, extrinsic (i.e. zoogeographic) barriers to gene flow, such that conspecific populations occupy easily recognizable branches on an intraspecific evolutionary tree. Another related possibility, not mutually exclusive, is extinction of intermediate genotypes in widely distributed species with limited dispersal and gene flow capabilities.

Apart from the mtDNA *phylogeographic* patterns per se, is there additional support for the significance of historical zoogeography in shaping intraspecific genetic architectures? At least two empirical lines of evidence can be advanced. First, populations separated for long times by zoogeographic barriers should also accumulate differences in the nuclear genome. Few studies have assayed nuclear genes (or their products) in concert with mtDNA, but two that have done so—involving the pocket gopher, *Geomys pinetis* (13) and the bluegill sunfish, *Lepomis macrochirus* (12)—found dramatic allozyme frequency distinctions between major mtDNA phylogenetic groups (Figure 5). Second, strong biogeographic barriers should mould the genetic structures of independently evolving species in concordant fashion. Five species of freshwater fishes have been assayed for mtDNA differentiation across river drainages in the southeastern United States—and, remarkably, all showed strong patterns of congruence in the geographic placements of the major mtDNA phylogenetic breaks (Figures 3, 5, and 6). To account for these

Table 1 Summary information from the larger phylogeographic surveys of mtDNA conducted in our laboratory. Original studies should be consulted for details.

Species	Number of			Different mtDNA genotypes	Geographic scale of survey	Mean number restriction sites scored	Phylogeographic category (Figure 4)	Mean number base substitutions per nucleotide	Reference
	Individuals	Locales	mtDNA genotypes						
Invertebrates									
<i>Limulus polyphemus</i> (horseshoe crab)	99	15	10	New Hampshire to Florida	41	I	0.020	77	
Freshwater fishes									
<i>Ameioba calva</i> (bowfin)	78	20	13	5 southeastern states	54	I	0.009	20	
<i>Lepomis punctatus</i> (spotted sunfish)	79	16	17	6 southeastern states	39	I	0.062	20	
<i>Lepomis microlophus</i> (redear sunfish)	77	17	7	6 southeastern states	48	I	0.087	20	
<i>Lepomis gulosus</i> (warmouth sunfish)	74	17	32	6 southeastern states	50	I	0.063	20	
<i>Lepomis macrochirus</i> (bluegill sunfish)	189	9	—	4 southeastern states	37	I	0.085	12	
Marine or catadromous fishes									
<i>Anguilla rostrata</i> (American eel)	109	7	23	Maine to Louisiana	78	IV	0.001	14	

Table 1 Summary information from the larger phylogeographic surveys of mtDNA conducted in our laboratory. Original studies should be consulted for details.

Species	Number of			Geographic scale of survey	Mean number restriction sites scored	Phylogeographic category (Figure 4)	Mean number base substitutions per nucleotide	Reference
	Individuals	Locales	Different mtDNA genotypes					
<u>Marine or catadromous fishes</u>								
<i>Arius jelskii</i> (hardhead catfish)	60	10	11	North Carolina to Louisiana	57	IV	0.005	16
<i>Barge marinus</i> (gafftopsail catfish)	12	5	4	Georgia to Florida panhandle	49	IV	0.005	16
<i>Opsanus tau</i> (oyster toadfish)	43	9	5	Massachusetts to Georgia	50	III	0.005	16
<i>Opsanus beta</i> (gulf toadfish)	17	4	8	Florida to Louisiana	54	III or V	0.004	16
<u>Amphibians</u>								
<i>Necturus</i> sp. ^{b,c} (mud puppies)	50	24	>22	North Carolina to Louisiana	38	I	≅0.060	Bermingham et al., in prep.
<i>Bufo terrestris</i> ^c (southern toad)	117	24	45	North Carolina to Louisiana	47	III	0.010	Bermingham and Avise, in prep.
<u>Reptiles</u>								
<i>Malaclemys terrapin</i> (diamondback terrapin) ^f	41	7	4	Massachusetts to Florida	54	III or V	.002	Lamb and Avise, in prep.

<i>Trachemys scripta</i> (yellow-bellied turtle) ^c	55	20	2	North Carolina to Texas	46	I or III	.007	Bermingham and Avisé in prep.
<i>Scaptocheilus agassizii</i> (desert tortoise) ^c	44	19	6	Southwestern states and Mexico	40	I	.051	Lamb and Avisé, in prep.
Birds								
<i>Agelaius phoeniceus</i> (red-winged blackbird) ^c	130	21	33	North Amer- ican continent	71	IV or V	.004	Ball et al., in prep.
Mammals								
<i>Geomys pinetis</i> (pocket gopher)	87	24	23	3 southeastern states	28	I	0.034	13
<i>Peromyscus maniculatus</i> (deer mouse)	135	40	61	North Amer- ican continent	39	I	0.040	61
<i>Peromyscus polionotus</i> (old-field mouse)	68	15	22	3 southeastern states	37	III or V	0.011	17
<i>Peromyscus leucopus</i> (white-footed mouse)	14	9	12	eastern and central United States	43	I	0.020	17

^a Between major phylogenetic arrays of mtDNA clones (if the outcome fell into phylogeographic category I), or among mtDNA clones within the entire species (if the outcome fell into phylogeographic categories III, IV, or V).

^b *N. alabamensis* and related forms and species whose taxonomic status is in dispute.

^c Study still in progress, and hence entries in this table are provisional and subject to possible revision.

results, we advanced a detailed biogeographic reconstruction—one that implicates historical patterns of river drainage isolation and coalescence associated with Pliocene and Pleistocene changes in sea level (19).

Preliminary evidence suggests that intraspecific phylogeographic discontinuities in mtDNA may commonly align with the boundaries of zoogeographic provinces as identified by more conventional biogeographic data. For example, from lists of distributional limits of freshwater fish species, Swift et al (84) identified two major zoogeographic provinces (east versus west of the Apalachicola River), plus additional subprovinces, in the southeastern United States. Boundary zones between these regions agreed quite well with the concentrations of intraspecific phylogenetic breaks in

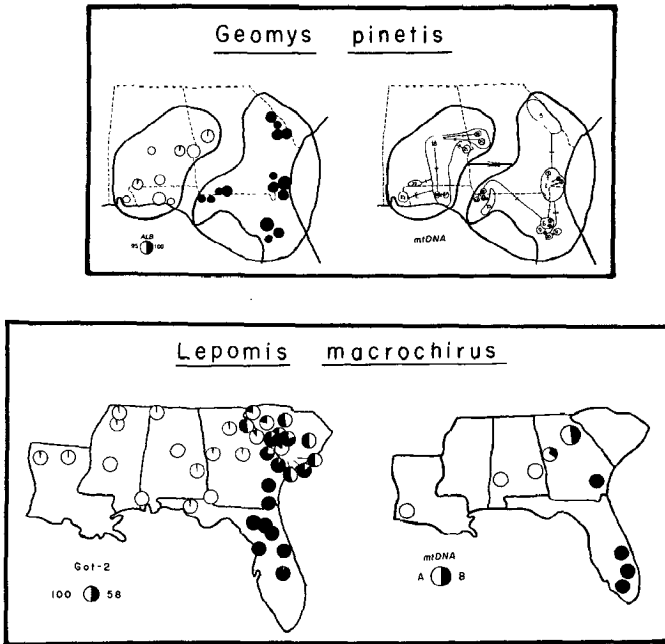

Figure 5 Empirical examples in which highly divergent mtDNA phylogeographic groupings also proved distinct in allozyme frequencies. Above: Data for southeastern pocket gopher, *Geomys pinetis* (13). On the left are pie diagrams summarizing geographic distributions (in three southern states) of the two electromorphs (labeled “95” and “100”) of the albumin locus. On the right is an mtDNA phylogenetic network, the most dramatic feature of which is the large genetic gap ($\hat{p} = 0.034$) distinguishing the same arrays of eastern versus western samples. Below: Data for the bluegill sunfish, *Lepomis macrochirus*. On the left are pie diagrams summarizing geographic distributions of electromorphs (labeled “100” and “58”) of the *Got-2* nuclear locus (from 11). On the right are pie diagrams of frequencies of two highly distinct ($\hat{p} = 0.085$) mtDNA genotypes (from 12).



Figure 6 Geographic distributions of major mtDNA clades in three additional species of sunfish, *Lepomis* (from 19). Within each species, major mtDNA phylogenetic breaks ($\bar{p} = 0.062$, 0.063, and 0.087 for *L. punctatus*, *L. gulosus*, and *L. microlophus*, respectively) distinguish fish in eastern rivers from those in drainages further to the west.

mtDNA for the five widely distributed fish species assayed by Bermingham & Avise (19). In another example, a genetic discontinuity between two phylogenetic assemblages of mtDNA's in the coastal horseshoe crab (77) occurred near Cape Canaveral, Florida, a region long-recognized as transitional between warm-temperate and tropical marine faunas (1, 22). Recognizable biogeographic provinces presumably exist because of environmental impediments (ecological and/or physical; historical as well as contem-

porary) to dispersal and gene flow. These impediments are conventionally recognized as reflected in concentrations of distributional limits for many species; perhaps they may also be reflected in concentrations of intraspecific phylogenetic discontinuities within species that have geographic distributions extending across zoogeographic provinces.

Category II—Phylogenetic Discontinuities, Lack of Spatial Separation

In surveys from our laboratory, we have no good empirical examples of the situation diagrammed in category II, Figure 4—mtDNA phylogenetic discontinuities not associated with spatial separation. Indeed, it has even been rare to observe large mtDNA differences (i.e. greater than about 1–2% nucleotide sequence divergence) between conspecific individuals collected at any given geographic site. One example involved the deer mouse *Peromyscus maniculatus* (61), in which, for unknown reasons, two or more moderately divergent mtDNA clones were occasionally found within particular localities in the eastern United States. For example, two mtDNA clones collected in Giles County, Virginia, differed by five restriction sites changes (in assays with eight endonucleases) and an estimated sequence divergence of $p \cong 0.013$. Even in *P. maniculatus*, however, the largest genetic differences in mtDNA (p values greater than about 0.03) were invariably between mice from different regions of North America (61), so that the overall pattern is more consistent with category I in Figure 4.

In a large sample of bluegill sunfish (*Lepomis macrochirus*) collected from Lake Oglethorpe in north Georgia, two grossly different mtDNA genotypes ($p \cong 0.085$) did co-occur in roughly equal frequency (12). Further analysis of this situation, involving more extensive geographic sampling as well as comparisons with nuclear genotypes (11), revealed that the Lake Oglethorpe population is probably a random-mating, hybrid swarm arising from secondary contact between allopatrically evolved races of bluegill. In such secondary admixture zones (as well as in cases where reproductively isolated sibling species are inadvertently assayed as if belonging to a single species), mtDNA phylogenetic discontinuities in the absence of current spatial separation are of course to be expected.

Category III—Phylogenetic Continuity, Spatial Separation

Not all assayed species have exhibited the large mtDNA phylogeographic “breaks” characteristic of category I. Another commonly encountered situation is one in which mtDNA parsimony networks are more or less continuous, with consistently small numbers of mutational steps (and fairly low p values) between phylogenetically adjacent clones, each of which is nonetheless confined to a subset of the geographic range of the species (III, Figure 4). Such a situation is approximated in the marine oyster toadfish *Opsanus tau* (16).

Among 43 individuals sampled from Massachusetts to Georgia, five closely related but geographically localized mtDNA genotypes were observed, each differing from its apparent closest relative by only one or two assayed restriction sites (and associated $p < 0.008$). The two most common genotypes were respectively confined to collections north versus south of the Cape Hatteras area in North Carolina (another boundary region between zoogeographic provinces (22)). Yet mean sequence divergence between the five mtDNA genotypes in *O. tau* was only $\bar{p} \cong 0.005$. Other species in which we have observed limited differentiation yet geographic localization of mtDNA clones include the gulf toadfish (*Opsanus beta*), diamondback terrapin (*Malaclemys terrapin*), and old-field mouse (*Peromyscus polionotus*) (Table 1). This phylogeographic pattern is also characteristic of the differentiation observed *within* particular regions for most of the category-I species previously listed (in other words, category III is similar to the within-region pattern of category I—Figure 4).

The most likely explanation for geographic localization of mtDNA clones and clades, in the absence of major phylogenetic breaks, involves historically limited gene flow between populations in species not subdivided by firm long-term zoogeographic barriers to dispersal. Thus, recently arisen mutations are confined to subsets of the species' range, and the overall population structure may conform more or less to either the "island" or "stepping stone" models in traditional population genetics (54).

Category IV—Phylogenetic Continuity, Lack of Spatial Separation

Within a few species, closely related mtDNA genotypes appear not to be geographically localized. Perhaps the best example involves the American eel, *Anguilla rostrata* (14). In 109 eels taken from seven locales between Maine and Louisiana, numerous related mtDNA genotypes were detected, yet each (when present in two or more individuals) was geographically widespread. Similarly, in the hardhead sea catfish (*Arius felis*), two related clades of mtDNA genotypes ($\bar{p} \cong 0.006$) were both widely distributed along the South Atlantic and Gulf of Mexico coastlines (16). Other assayed species exhibiting limited mtDNA phylogenetic diversity and relatively little geographic structure include the marine gafftopsail catfish (*Bagre marinus*), the red-winged blackbird (*Agelaius phoeniceus*) (Table 1), and, to an argued extent, humans (24, 94).

We propose that geographic populations of species exhibiting this category of intraspecific phylogeography have had relatively extensive and recent historical interconnections through gene flow. This would require the absence of firm and longstanding zoogeographic barriers to movement, as well as life histories conducive to dispersal. All of the above examples can at least provisionally be understood in these terms. American eels have a

catadromous life history—mass spawning takes place in the western tropical mid-Atlantic Ocean, and larvae are transported (perhaps passively) to coastal regions by ocean currents. Young eels mature in freshwater before completing the life cycle by migrating back to the mid-Atlantic for spawning. Thus, any freshwater population in the Americas may contain a nearly random draw of genotypes from what is effectively a single mating pool. The eel life-history pattern is highly unusual, but other marine fishes, such as the marine catfish which are active swimmers as adults, may also prove to exhibit the “category-IV” phylogeographic pattern (8, 16, 48). Marine fish occupy a realm *relative* free of solid geographic barriers to dispersal (at least over major portions of their ranges and in comparison to those of their freshwater counterparts that are necessarily confined to specific drainages for moderate lengths of evolutionary time). Many marine fishes also possess great dispersal capabilities, either as pelagic larvae, juveniles, and/or adults.

Birds constitute another group of potentially highly mobile animals for which the “category-IV” phylogeographic pattern may prove to be common. For example, populations of the red-winged blackbird, *Agelaius phoeniceus*, (the only avian species extensively assayed at the time of this writing) exhibited very limited mtDNA phylogeographic structure across all of North America (Table 1). Red-winged blackbirds are known to be moderately nest-site philopatric (average distances between banding and recovery at nesting sites in successive years are generally less than 50 km; 37), so the documentation of a “category-IV” pattern clearly cannot be taken to imply panmixia or even long-distance gene flow on a generation-to-generation scale. Rather, we suspect that these blackbirds (and other species in phylogeographic category IV) have had a relative fluidity of movement (in birds, obviously facilitated by the capacity for flight) over a recent evolutionary time scale such that populations have been in solid genetic contact within, perhaps, the last few tens of thousands of generations (see next section).

For humans, assays of mtDNA from individuals of diverse racial and geographic origin revealed only a weak tendency for phylogenetic structuring of groups, according to Cann et al (33; see also 24, 27, 30, 31, 32). Based on a conventional mtDNA clock calibration of 2% nucleotide sequence divergence per million years, Cann et al (31) proposed a mean interracial divergence time in humans of about 50,000 years, and Brown (24) and Cann et al (33) hypothesized a common (female) ancestor for all humans about 200,000 years ago. Cann et al (33) also argue from the mtDNA data that this female ancestor lived in Africa. For any species whose numbers and ranges have expanded dramatically from a single refugium or place of origin in recent evolutionary times, mtDNA phylogeographic differentiation should similarly be quite limited.

Using independently obtained data, Johnson et al (57) report a greater degree of geographic and racial clustering of human mtDNA genotypes than

did the Cann et al (31, 32, 33) research group. MtDNA genotypes thought to be ancestral for humans were geographically and racially widespread, but genotypes presumed derived were often race specific. Thus, according to the Johnson et al data (57; see also 94), humans are better characterized as exhibiting the category-V phylogeographic pattern (see below).

Category V—Phylogenetic Continuity, Partial Spatial Separation

The four phylogeographic categories listed above are of course somewhat arbitrarily selected though distinct points from a wide field of possibilities. We include category V here and in Figure 4 only to provide an example of one type of intermediate situation. In this category, some mtDNA genotypes are geographically widespread, while allied genotypes are localized, such that the overall pattern is one of a nested series of phylogeographic relationships. Besides humans, we have already mentioned one other example. In the eastern mtDNA clonal assemblage of the bowfin fish *Amia calva* (Figure 3), mtDNA genotype 1 was present in nine of ten surveyed river drainages, while each of eight other genotypes was apparently confined to one or a few adjacent drainages within the range of genotype 1. A reasonable hypothesis for this eastern assemblage is that genotype 1 is plesiomorphic (ancestral), while the other genotypes are apomorphic (derived). Individual fish sharing the derived states (i.e. possessing synapomorphic mtDNA traits) form various monophyletic groups (with respect to maternal ancestry). But because of the possibility of joint retention of the ancestral condition, individuals sharing genotype 1 do not necessarily form a clade within the eastern assemblage of bowfin (although compared to bowfin in the western drainages, they may still form a broader clade including all eastern genotypes).

Phylogeographic category V might be anticipated in species or subsets of species with historically intermediate levels of gene flow between geographic populations. Thus, unlike category III, presumed ancestral genotypes occur over a broad area; while unlike category IV, newly arisen mutations have not yet spread throughout the range of a species. Nonetheless, in practice this intermediate situation may normally be difficult to distinguish clearly from categories III or IV, respectively (Table 1).

MTDNA EVOLUTIONARY TREES ARE SELF-PRUNING

mtDNA transmission is the female analogue of “male surname transmission” in many human societies: Progeny of both sexes inherit mitochondria from their mothers, but only daughters subsequently transmit mtDNA to future generations. Thus, mtDNA (and surnames) are examples of asexually transmitted traits within otherwise sexually reproducing species. Realistic statistical models of mtDNA evolution must accommodate this mode of inheritance;

they must also somehow account for the empirical rarity of major mtDNA phylogenetic gaps within local populations (category II, Figure 4), and the common occurrence of monophyletic groupings among allopatric populations (categories I and III, Figure 4). The method of applying generating functions to the distributions of family size in a branching process (51) is a relevant probabilistic approach that has been used to study the dynamics of surnames (65, 66, 82) as well as mtDNA lineages (15, 73).

Assume, for example, that adult females within a population produce daughters according to a Poisson distribution with mean μ . The probability of loss of a given female lineage after one generation (or the proportion of such lineages lost from the population) is then $e^{-\mu}$, and the probability of loss after G generations is given by the generating function $p_G = e^{\mu(x-1)}$, where x equals the probability of loss in the previous generation (82). (Generating functions are also available for other parametric family size distributions, such as the binomial.) In the Poisson case, if mothers leave on average one surviving daughter, about 37% of the maternal lineages will by chance go extinct in the first generation, and less than 2% of the original mothers will likely have successfully contributed mtDNA molecules to the population 100 generations later.

Avise et al (15) used an extension of this approach to estimate probabilities (π) of survival of *two or more* independent mtDNA lineages through time. In the Poisson situation, with μ (and hence also the variance, ν) equal to 1.0, within about $4n$ generations all individuals within a stable-sized population begun with n females will with high probability trace maternal ancestries to a single foundress (Figure 7); and the times in generations to intermediate levels of π are roughly n to $2n$. That is, all mtDNA sequence differences would almost certainly have arisen less than $4n$ generations earlier and more probably within n to $2n$ generations. Lineage sorting can be much more rapid than this when the variance in progeny numbers across females is greater. For example, in computer simulations where females produced daughters according to a negative binomial distribution with $\mu = 1.0$ and $\nu = 5.0$, individuals *invariably* stemmed from a single female ancestor less than $2n$ generations earlier (Figure 7). The variances in progeny survival between families are probably large in many species.

In general then, stochastic mtDNA lineage extinction within a population is expected to occur at a (counterintuitively) rapid pace, with the net effect of continually truncating the frequency spectrum of times to common mtDNA ancestry. In other words, due simply to the stochastic lineage turnover associated with the vagaries of reproduction, mtDNA evolutionary trees are continually "self-pruning." This line of reasoning may largely account for limited mtDNA sequence divergence values (e.g. \bar{p} usually much less than about 0.01) observed within local populations, or within entire species char-

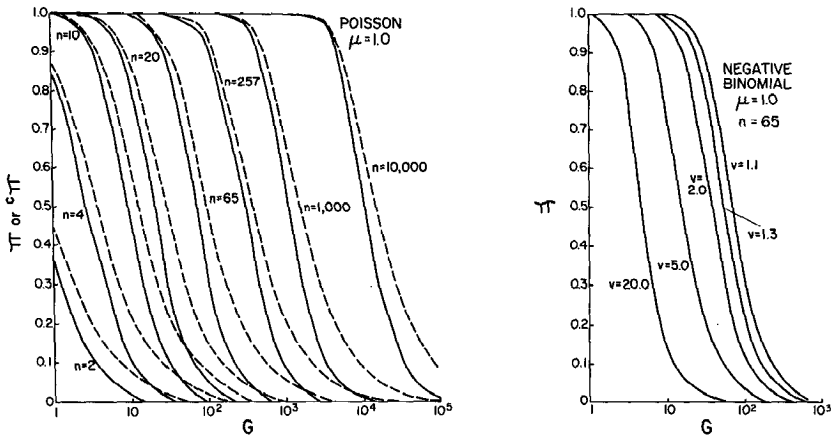

Figure 7 left: Solid lines are theoretical probabilities (π) of survival of two or more mtDNA lineages through G generations within populations founded by n females producing daughters according to a Poisson distribution with mean 1.0. Dashed lines are conditional probabilities (π_c) that two or more lineages survive, given that the population remains extant. Right: π values within populations founded by $n = 65$ females producing daughters according to a negative binomial distribution with mean 1.0 and variances (v) ranging from 1.1 to 20.0 (from 15).

acterized by historically high levels of gene flow and/or recent expansion from a single refugium.

On the other hand, the empirical existence of major mtDNA phylogenetic gaps within so many species (Table 1) also implies the operation of processes acting dramatically to inhibit extinction of some mtDNA clades, such that much larger genetic differences than those normally observed *within* populations have had time to accumulate. Since such phylogenetic gaps are almost invariably observed between allopatric populations, it seems reasonable that long-term population isolation is responsible. Suppose a particular species has been subdivided historically into two or more spatially isolated populations. Although the genetic distances between lineages within each population will be limited by the balance between the rate of novel mtDNA mutations and female lineage extinction, at least one mtDNA lineage per extant population will be retained indefinitely, and the distinction between these mtDNA lineages could be no less than that which had accumulated since the time of the original population separation.

Neigel & Avise (73) have, by computer simulation of branching processes, formalized these latter ideas and couched them in the language of systematics. (Our models were developed for "species differences" in mtDNA, but they apply equally well to expected relationships between spatially isolated conspecific populations). Suppose that from ancestral stock, populations A and B have separated recently (less than about n generations earlier, where n is the

carrying capacity of females in each daughter population). Then because of stochastic mtDNA lineage sorting at and subsequent to population separation, it is likely that some individuals within A are in reality more closely related (i.e. have shared a female ancestor more recently) to some individuals of B than they are to other members of A; and conversely, some members of B are phylogenetically closer to some A's than to some B's. Populations A and B could thus be said to be polyphyletic in matriarchal ancestry. However, through time mtDNA lineage extinction continues inexorably within populations, such that after about $3n$ to $4n$ generations, populations A and B would with high probability appear monophyletic with respect to one another. At intermediate times of separation from ancestral stock, populations A and B could reasonably be expected to exhibit a paraphyletic relationship. Figure 8 plots results of a typical computer simulation summarizing probabilities of poly-, para-, and monophyly of isolated populations as a function of time since population separation. These times were observed under the Poisson distribution of family size. For larger variances in progeny numbers (or when founder effect is severe), expected times to reciprocal monophyly of populations would be even lower. Thus, particularly for species composed of many small demes (and limited gene flow between them), allopatric populations should often be monophyletic in matriarchal ancestry. Whether or not they would appear to be so in an mtDNA survey might well depend on the level of laboratory effort expended (i.e. the number of restriction sites assayed) in the search for synapomorphic character states. The larger phylogenetic gaps (category I, Figure 4) should occur between demic arrays

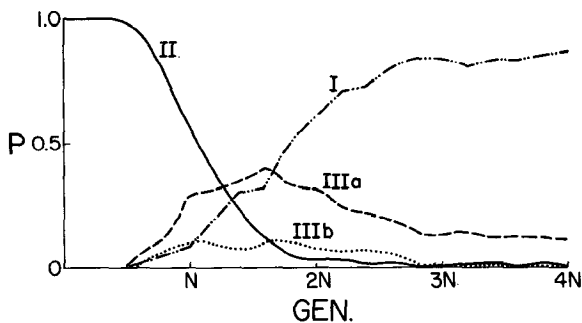

Figure 8 Example of results from computer simulations monitoring probabilities (P) of monophyly (curve I), polyphyly (II) and paraphyly (III a,b) of two isolated populations G generations after their separation from ancestral stock (from 73). In each of 400 replicate simulations, the daughter populations were founded by 300 and 200 individuals, respectively, drawn at random from an ancestral stock. The daughter populations were subsequently density regulated at carrying capacities $k = 300$ and $k = 200$ by constraining the mean number of female progeny per mother as follows: $\mu = e^{(k-n)/k}$. N is equal to 300.

isolated for especially long periods of time and should be easiest to detect (as well as most strongly supported statistically by procedures such as bootstrapping; Figure 3C).

Can these models be related to observed rates of mtDNA evolution and census population sizes in more concrete fashion? From empirical experience, individuals in localized geographic areas, and in entire species in phylogeographic category IV, usually show estimates of mtDNA nucleotide sequence divergence much less than about $p = 0.008$. Using Brown et al's (28) conventional mtDNA clock calibration, this implies an *upper bound* on times since common female ancestry of about 400,000 years. This would be roughly compatible with expectations for a population (or set of populations well interconnected by gene flow) of perhaps $n \cong 400,000$ females, provided the population has a generation length of 1 year, has been fairly stable in size, and has μ and ν near 1.0. But because branching process theory yields only probabilistic outcomes, and because mtDNA lineage survivorship is likely to have a large stochastic component, it would not at all be surprising for that same population to have been of size anywhere from, say, $n = 200,000$ to 1,000,000 or more (Figure 7). And some very different demographic scenarios would not be ruled out. For example, absolute population size could have been vastly larger throughout much of the evolution of the species, but by chance, two mtDNA lineages dating to 400,000 years ago happened to squeeze through more recent bottlenecks in population size. Thus, evolutionary reconstructions regarding population size and times of ancestry should be presented with due caution; and for most populations, we may never have direct and detailed knowledge of historical demography against which to evaluate possible inferences from present-day mtDNA diversities.

Nonetheless, unless the rate of mtDNA evolution is anomalously high in particular populations, the major phylogeographic gaps observed in many species strongly suggest long times since common female ancestry for some conspecifics—much longer than is observed empirically *within* local populations. For example, from the mtDNA data for the eastern versus western monophyletic groupings of the redear sunfish *Lepomis microlophus* (Figure 6), mean population separation (corrected for within-region divergence) occurred about 4 million years ago, and some mtDNA lineages within the species may date to as much as 5 million years BP (20). Similar values apply to allopatric clades within several other species in Table 1.

ECOGEOGRAPHY AND PHYLOGEOGRAPHY

Data on within-species variability in mtDNA thus lend themselves to examination from two vantages: (a) phylogenetic interrelationships among the mtDNA molecules themselves and (b) geographic distributions of the

phylogenetic groupings. Jointly, these elements constitute concerns of a discipline that might be termed *intraspecific phylogeography*.

Notwithstanding occasional examples of concern with the influence of historical population subdivision in shaping genetic architecture at the intraspecific level (e.g. 2, 75), attention seems more conventionally to have been focused on possible adaptive explanations (the “adaptationist paradigm”) for geographic differences in attributes such as morphology or behavior (47). One line of evidence for this preoccupation has been the formulation of several “ecogeographic rules” summarizing recognizable trends in presumed adaptive responses to geographically varying environmental conditions (23). For example, Bergmann’s rule notes a tendency in homeotherms for larger body sizes at higher latitudes (presumably a surface/volume adaptation for heat conservation in colder climates); Allen’s rule notes a latitudinal trend in lengths of limbs (shorter extremities may similarly conserve heat in cold climates); and Gloger’s rule notes a tendency for populations in humid areas to be more heavily pigmented (probably a manifestation of selection for background-matching related to predation and competition). While these and other ecogeographic rules at best represent general trends with many exceptions (98), they have been provocative and informative constructs. In this same spirit, we want to suggest several *phylogeographic hypotheses* that may serve as a stimulus for further considerations of geographic trends in intraspecific phylogeny.

We take it as axiomatic that the extended pedigree within any species constitutes its intraspecific phylogeny and that genes transmitted through this pedigree can in principle provide genealogical tracings of hereditary history. As emphasized, data from mtDNA allow estimation of one specified component of the pedigree—the matriarchal phylogeny. Thus, the historical picture recorded in mtDNA is far from a complete characterization of intraspecific phylogeny, and that picture may be especially distorted if males and females differ in phylogeographically relevant characteristics, such as variances in progeny numbers or levels of dispersal (87, 88). Yet techniques of mtDNA assay have provided the first extensive and readily accessible data in the form of “gene genealogies” at the intraspecific level. The following phylogeographic hypotheses are motivated by the mtDNA data and theory currently available and are offered within that context.

Phylogeographic Hypotheses

(a) *Most species are composed of geographic populations whose members occupy different branches of an intraspecific, phylogenetic tree.* Such geographic partitioning of phylogenetic branches can be termed phylogeographic population structure. The magnitude of genetic distance between branches can range from small to great, but not uncommonly, geographic clades are distinguished by large phylogenetic gaps or breaks.

(b) *Species with limited phylogeographic population structure have life histories conducive to dispersal and have occupied ranges free of firm impediments to gene flow.* Such species have had a relative fluidity of geographic movement over recent evolutionary time and may be especially common in certain groups such as flying insects, birds, and marine fishes, or in species such as the human that have expanded recently from a single refugium. Genealogical distances within such species are constrained because of the inevitable extinction of lineages expected within populations behaving as a single demographic unit in evolution.

(c) *Monophyletic groups distinguished by large phylogenetic gaps usually arise from long-term extrinsic (zoogeographic) barriers to gene flow.* Since reproduction leads to a continual turnover of lineages, isolated populations should evolve through time to a condition of reciprocal monophyly, and the time of isolation should be positively correlated (all else being equal) with the magnitude of genealogical differentiation. This hypothesis has a series of corollaries that also serve as predictions for further empirical tests of the expectation:

(i) *As time since isolation increases, the degree of phylogeographic concordance across separate gene genealogies increases.* That is, phylogenetic differentiation between long-isolated populations (either in refugia or in situ) should be reflected in appropriate assays of numerous nuclear as well as cytoplasmic genes.

(ii) *The geographic placements of phylogenetic gaps are concordant across species.* That is, long-term barriers to gene flow should tend to mold the intraspecific genetic architectures of species with similar life histories in geographically concordant fashion.

(iii) *Phylogenetic gaps within species are geographically concordant with boundaries between traditionally recognized zoogeographic provinces.* That is, to the extent that biogeographic provinces reflected in species' distributional limits exist because of environmental barriers to gene flow, such barriers may also tend to result in geographic concentrations of boundaries between well-differentiated clades within species.

Whether or not these hypotheses are confirmed with additional data, we feel that concern with intraspecific phylogeography should assume a place in evolutionary study at least commensurate with ecogeography. Indeed, ecogeography will also benefit from this new enterprise. Let us give two empirical examples. In the deer mouse *Peromyscus maniculatus*, mammalogists have recognized two distinct morphotypes—a long-tailed, long-eared form typically associated with forest environments, and a short-tailed, short-eared form more characteristic of grasslands (21). Data from mtDNA clearly indicate that at least with respect to matriarchal ancestry, these morphotypes do not constitute separate evolutionary clades (61). The extensive mtDNA phylogenetic structure in *P. maniculatus* across North America is strongly oriented to geography and bears no consistent relationship to these morphological distinctions. Such findings add support to earlier suggestions that the

ear and tail length differences represent selection-driven responses to ecological challenges posed by forests and grassland and have arisen more than once in separate evolutionary lines. For a counterexample, in the bluegill sunfish *Lepomis macrochirus*, ichthyologists have also recognized two distinct morphological and physiological forms (56). In this case the morphological "races" proved to belong to highly divergent branches in an intraspecific evolutionary tree (Figure 5; 11, 12). This of course in no way excludes natural selection as a possible factor influencing the evolution of these racial differences.

In a recent review of geographic variation in allozymes, Selander & Whittam (79) concluded: "studies of protein polymorphisms indicate that a great variety of organisms, ranging from bacteria to humans . . . , are strongly structured genetically and that their evolution cannot be understood without reference to this structure." Data from mtDNA have revealed an even greater degree of population structure for many species. But more importantly, the nature of assayable mtDNA differences has allowed relatively unambiguous documentation of a strong phylogenetic component to geographic differentiation. Most species have a rich phylogeographic diversity characterized by localized clades and, not infrequently, important phylogenetic gaps between allopatric populations. Many mtDNA lineages within species date to common ancestors several million years BP. Thus, no longer will it be defensible to consider species as phylogenetically monolithic entities in scenarios of speciation or macroevolution. Phylogenetic differences within species are qualitatively of the same kind as, though often smaller in magnitude than, those normally pictured in higher-order phylogeny reconstructions. To paraphrase and update the statement by Selander & Whittam quoted above: Studies of mtDNA polymorphisms indicate that a great many species are strongly structured phylogenetically and that their evolution cannot be fully understood without references to this intraspecific phylogeographic structure.

SUMMARY

Mitochondrial DNA has provided the first extensive and readily accessible data available to evolutionists in a form suitable for strong genealogical inference at the intraspecific level. The rapid pace of mtDNA nucleotide substitution, coupled with the special mode of maternal nonrecombining mtDNA inheritance, offers advantages for phylogenetic analysis at the microevolutionary level that will not be matched easily by any nuclear gene system. These peculiarities of mtDNA data have literally forced the addition of a phylogenetic perspective to studies of intraspecific evolutionary process and as such have provided an empirical and conceptual bridge between the nominally rather separate disciplines of systematics and population genetics.

MtDNA has also served to clarify thinking about the distinction between (yet relevance of) gene genealogies to organismal phylogeny.

Many species have proved to exhibit a deep and geographically structured mtDNA phylogenetic history. Study of the relationship between genealogy and geography constitutes a discipline that can be termed intraspecific phylogeography. We present several phylogeographic hypotheses that were motivated by available data and that represent possible trends whose broader generality remains to be tested. Study of intraspecific phylogeography should assume a place in evolutionary biology at least commensurate with that of ecogeography, with mutual benefit resulting to both disciplines. Theories of speciation and macroevolution must now recognize and accommodate the reality of phylogeographic differentiation at the intraspecific level.

ACKNOWLEDGMENTS

We wish to thank Dr. Bob Lansman for introducing us to mitochondrial DNA. John C. Avise's laboratory has been supported by grants from NSF. Publication costs were funded by contract DE-AC09-76SR00-819 between the US Department of Energy and the University of Georgia Institute of Ecology.

Literature Cited

1. Abbott, R. 1957. The tropical western Atlantic province. *Proc. Phila. Shell Club* 1:7-11
2. Ammerman, A. J., Cavalli-Sforza, L. L. 1984. *The Neolithic Transition and the Genetics of Populations in Europe*. Princeton, NJ: Princeton Univ. Press
3. Aquadro, C. F., Greenberg, B. D. 1983. Human mitochondrial DNA variation and evolution: Analysis of nucleotide sequences from seven individuals. *Genetics* 103:287-312
4. Aquadro, C. F., Kaplan, N., Risko, K. J. 1984. An analysis of the dynamics of mammalian mitochondrial DNA sequence evolution. *Molec. Biol. Evol.* 1:423-34
5. Asmussen, M. A., Arnold, J., Avise, J. C. 1987. Definition and properties of disequilibrium statistics for associations between nuclear and cytoplasmic genotypes. *Genetics* 115:755-68
6. Avise, J. C. 1983. Protein variation and phylogenetic reconstruction. In *Protein Variation: Adaptive and Taxonomic Significance*, ed. G. Oxford, D. Rollinson, pp. 103-30. London: Syst. Assoc. Publ. Br. Mus. Nat. History
7. Avise, J. C. 1986. Mitochondrial DNA and the evolutionary genetics of higher animals. *Phil. Trans. R. Soc. Lond. B312*:325-42
8. Avise, J. C. 1987. Identification and interpretation of mitochondrial DNA stocks in marine species. In *Proc. Stock Identification Workshop*, ed. H. Kumpf, E. L. Nakamura, pp. Panama City, FL: Publ. Natl. Oceanogr. Atmos. Admin. In press
9. Avise, J. C., Ayala, F. J. 1975. Genetic change and rates of cladogenesis. *Genetics* 81:757-73
10. Avise, J. C., Lansman, R. A. 1983. Polymorphism of mitochondrial DNA in populations of higher animals. In *Evolution of Genes and Proteins*, ed. M. Nei, R. K. Koehn, pp. 147-64. Sunderland, Mass: Sinauer
11. Avise, J. C., Smith, M. H. 1974. Biochemical genetics of sunfish. I. Geographic variation and subspecific intergradation in the bluegill, *Lepomis macrochirus*. *Evolution* 28:42-56
12. Avise, J. C., Bermingham, E., Kessler, L. G., Saunders, N. C. 1984. Characterization of mitochondrial DNA variability in a hybrid swarm between subspecies of bluegill sunfish (*Lepomis macrochirus*). *Evolution* 38:931-41
13. Avise, J. C., Giblin-Davidson, G.,

- Laerm, J., Patton, J. C., Lansman, R. A. 1979. Mitochondrial DNA clones and matriarchal phylogeny within and among geographic populations of the pocket gopher, *Geomys pinetis*. *Proc. Natl. Acad. Sci. USA* 76:6694-98
14. Avise, J. C., Helfman, G. S., Saunders, N. C., Hales, L. S. 1986. Mitochondrial DNA differentiation in North Atlantic eels: Population genetic consequences of an unusual life history pattern. *Proc. Natl. Acad. Sci. USA* 83:4350-54
15. Avise, J. C., Neigel, J. E., Arnold, J. 1984. Demographic influences on mitochondrial DNA lineage survivorship in animal populations. *J. Mol. Evol.* 20:99-105
16. Avise, J. C., Reeb, C. A., Saunders, N. C. 1987. Geographic population structure and species differences in mitochondrial DNA of mouthbrooding marine catfishes (Ariidae) and demersal spawning toadfishes (Batrachoididae). *Evolution*. In press
17. Avise, J. C., Shapira, J. F., Daniel, S. W., Aquadro, C. F., Lansman, R. A. 1983. Mitochondrial DNA differentiation during the speciation process in *Peromyscus*. *Mol. Biol. Evol.* 1:38-56
18. Ayala, F. J., ed. 1976. *Molecular Evolution*. Sunderland, Mass: Sinauer
19. Bermingham, E., Avise, J. C. 1986. Molecular zoogeography of freshwater fishes in the southeastern United States. *Genetics* 113:939-65
20. Bermingham, E., Lamb, T., Avise, J. C. 1986. Size polymorphism and heteroplasmy in the mitochondrial DNA of lower vertebrates. *J. Heredity* 77:249-52
21. Blair, W. F. 1950. Ecological factors in speciation of *Peromyscus*. *Evolution* 4:253-75
22. Briggs, J. C. 1974. *Marine Zoogeography*. New York: McGraw-Hill
23. Brown, J. H., Gibson, A. C. 1983. *Biogeography*. St. Louis, Mo: C. V. Mosby
24. Brown, W. M. 1980. Polymorphism in mitochondrial DNA of humans as revealed by restriction endonuclease analysis. *Proc. Natl. Acad. Sci. USA* 77:3605-9
25. Brown, W. M. 1983. Evolution of animal mitochondrial DNA. In *Evolution of Genes and Proteins*, ed. M. Nei, R. K. Koehn, pp. 62-88. Sunderland, Mass: Sinauer
26. Brown, W. M. 1985. The mitochondrial genome of animals. In *Molecular Evolutionary Genetics*, ed. R. J. MacIntyre, pp. 95-130. New York: Plenum
27. Brown, W. M., Goodman, H. M. 1979. Quantitation of intrapopulation variation by restriction analysis of human mitochondrial DNA. In *Extrachromosomal DNA*, ed. D. J. Cummings, P. Borst, I. B. Dawid, S. M. Weissman, C. F. Fox, pp. 485-500. New York: Academic
28. Brown, W. M., George, M. Jr., Wilson, A. C. 1979. Rapid evolution of animal mitochondrial DNA. *Proc. Natl. Acad. Sci. USA* 76:1967-71
29. Brown, W. M., Prager, E. M., Wang, A., Wilson, A. C. 1982. Mitochondrial DNA sequences of primates: Tempo and mode of evolution. *J. Mol. Evol.* 18:225-39
30. Cann, R. L., Wilson, A. C. 1983. Length mutations in human mitochondrial DNA. *Genetics* 104:699-711
31. Cann, R. L., Brown, W. M., Wilson, A. C. 1982. Evolution of human mitochondrial DNA: A preliminary report. In *Human Genetics, Part A, The unfolding genome*, ed. B. Bonné-Tamir, P. Cohen, and R. N. Goodman, pp. 157-65. New York: Liss
32. Cann, R. L., Brown, W. M., Wilson, A. C. 1984. Polymorphic sites and the mechanism of evolution of human mitochondrial DNA. *Genetics* 106:479-99
33. Cann, R. L., Stoneking, M., Wilson, A. C. 1987. Mitochondrial DNA and human evolution. *Nature* 325:31-36
34. Chapman, R. W., Stephens, J. C., Lansman, R. A., Avise, J. C. 1982. Models of mitochondrial DNA transmission genetics and evolution in higher eucaryotes. *Genet. Res.* 40:41-57
35. Crow, J. F., Kimura, M. 1970. *An Introduction to Population Genetic Theory*. New York: Harper & Row
36. Dobzhansky, T. 1937. *Genetics and the Origin of Species*. New York: Columbia Univ. Press
37. Dolbeer, R. A. 1978. Movement and migration patterns of red-winged blackbirds: A continental overview. *Bird Banding* 49:17-34
38. Eldrege, N., Gould, S. J. 1972. Punctuated equilibria: An alternative to phyletic gradualism. In *Models in Paleobiology*, ed. T. J. M. Schopf, pp. 82-115. San Francisco, Calif: Freeman, Cooper
39. Falconer, D. S. 1981. *Introduction to Quantitative Genetics*. New York: Longman. 2nd ed.
40. Felsenstein, J. 1982. Numerical methods for inferring evolutionary trees. *Q. Rev. Biol.* 57:379-404
41. Felsenstein, J. 1985. Confidence limits on phylogenies: An approach utilizing the bootstrap. *Evolution* 39:783-91

42. Fink, W. L. 1986. Microcomputers and phylogenetic analysis. *Science* 234: 1135-39
43. George, M. Jr, Ryder, O. A. 1986. Mitochondrial DNA evolution in the genus *Equus*. *Mol. Biol. Evol.* 3:535-46
44. Gillespie, J. H. 1986. Rates of molecular evolution. *Ann. Rev. Ecol. Syst.* 17:637-65
45. Goldschmidt, R. 1940. *The Material Basis of Evolution*. New Haven, Conn: Yale Univ. Press
46. Gould, S. J. 1980. Is a new and general theory of evolution emerging? *Paleobiology* 6:119-30
47. Gould, S. J., Lewontin, R. C. 1979. The spandrels of San Marco and the Panglossian paradigm: A critique of the adaptationist programme. *Proc. Royal Soc. London Ser. B* 205:581-98
48. Graves, J. E., Ferris, S. D., Dizon, A. E. 1984. Close genetic similarity of Atlantic and Pacific skipjack tuna (*Katsuwonus pelamis*) demonstrated with restriction endonuclease analysis of mitochondrial DNA. *Mar. Biol.* 79:315-19
49. Grivell, L. A. 1983. Mitochondrial DNA. *Sci. Am.* 248:78-89
50. Gyllenstein, U., Wharton, D., Wilson, A. C. 1985. Material inheritance of mitochondrial DNA during backcrossing of two species of mice. *J. Hered.* 76:321-24
51. Harris, T. 1963. *The Theory of Branching Processes*. Berlin: Springer-Verlag
52. Hauswirth, W. W., Laipis, P. J. 1985. Transmission genetics of mammalian mitochondria: A molecular model and experimental evidence. In *Achievements and Perspectives of Mitochondrial Research*, Vol. II: *Biogenesis*, ed. E. Quagliariello, E. C. Slater, F. Palmieri, C. Saccone, A. M. Kroon, pp. 49-60. New York: Elsevier
53. Hecht, M. K., Hoffman, A. 1986. Why not neo-Darwinism? A critique of paleobiological challenges. *Oxford Surv. Evol. Biol.* 3:1-47
54. Hedrick, P. W. 1983. *Genetics of Populations*. New York: Van Nostrand Reinhold
55. Hennig, W. 1966. *Phylogenetic Systematics*. Urbana: Univ. Ill. Press
56. Hubbs, C. L., Allen, E. R. 1944. Fishes of Silver Springs, Florida. *Proc. Fla. Acad. Sci.* 6:110-30
57. Johnson, M. J., Wallace, D. C., Ferris, S. D., Rattazzi, M. C., Cavalli-Sforza, L. L. 1983. Radiation of human mitochondrial DNA types analyzed by restriction endonuclease cleavage patterns. *J. Mol. Evol.* 19:255-71
58. Kimura, M., Ohta, T. 1971. *Theoretical Aspects of Population Genetics*. Princeton, NJ: Princeton Univ. Press
59. King, J. L., Jukes, T. H. 1969. Non-Darwinian evolution: Random fixation of selectively neutral mutations. *Science* 164:788-98
60. Lansman, R. A., Avise, J. C., Huettel, M. D. 1983. Critical experimental test of the possibility of "paternal leakage" of mitochondrial DNA. *Proc. Natl. Acad. Sci. USA* 80:1969-71
61. Lansman, R. A., Avise, J. C., Aquadro, C. F., Shapira, J. F., Daniel, S. W. 1983. Extensive genetic variation in mitochondrial DNAs among geographic populations of the deer mouse, *Peromyscus maniculatus*. *Evolution* 37:1-16
62. Lansman, R. A., Shade, R. O., Shapira, J. F., Avise, J. C. 1981. The use of restriction endonucleases to measure mitochondrial DNA sequence relatedness in natural populations. III. Techniques and potential applications. *J. Mol. Evol.* 17:214-26
63. Lewontin, R. C. 1974. *The Genetic Basis of Evolutionary Change*. Columbia Univ. Press, NY.
64. Li, C. C. 1955. *Population Genetics*. Chicago: Univ. Chicago Press
65. Lotka, A. J. 1931. Population analysis—the extinction of families. I. *J. Wash. Acad. Sci.* 21:453-59
66. Lotka, A. J. 1931. Population analysis—the extinction of families. II. *J. Wash. Acad. Sci.* 21:453-59
67. Mayr, E. 1963. *Animal Species and Evolution*. Cambridge, Mass: Belknap Press, Harvard
68. Mayr, E. 1982. Speciation and macroevolution. *Evolution* 36:1119-32
69. Moritz, C., Brown, W. M. 1986. Tandem duplication of D-loop and ribosomal RNA sequences in lizard mitochondrial DNA. *Science* 233:1425-27
70. Nei, M. 1975. *Molecular Population Genetics and Evolution*. New York: Elsevier
71. Nei, M. 1987. *Molecular Evolutionary Genetics*. New York: Columbia Univ. Press
72. Nei, M., Li, W.-H. 1979. Mathematical model for studying genetic variation in terms of restriction endonucleases. *Proc. Natl. Acad. Sci. USA* 76:5269-73
73. Neigel, J. E., Avise, J. C. 1986. Phylogenetic relationships of mitochondrial DNA under various demographic models of speciation. In *Evolutionary Processes and Theory*, ed. E. Nevo, S. Karlin, pp. 515-34. New York: Academic

74. O'Brien, T. W., Denslow, N. D., Harville, T. O., Hessler, R. A., Matthews, D. E. 1980. Functional and structural roles of proteins in mammalian mitochondrial ribosomes. In *The Organization and Expression of the Mitochondrial Genome*, ed. A. M. Kroon, C. Saccone, pp. 301–305. New York: Elsevier
75. Ochman, H., Jones, J. S., Selander, R. K. 1983. Molecular area effects in *Cepaea*. *Proc. Natl. Acad. Sci. USA* 80:4189–93
76. Rand, D. M., Harrison, R. G. 1986. Mitochondrial DNA transmission genetics in crickets. *Genetics* 114:955–70
77. Saunders, N. C., Kessler, L. G., Avise, J. C. 1986. Genetic variation and geographic differentiation in mitochondrial DNA of the horseshoe crab, *Limulus polyphemus*. *Genetics* 112:613–27
78. Schweyen, R. J., Wolf, K., Kaudewitz, F. eds. 1983. *Mitochondria 1983, Nucleo-Mitochondrial Interactions*. New York: de Gruyter Publ.
79. Selander, R. K., Whittam, T. S. 1983. Protein polymorphism and the genetic structure of populations. In *Evolution of Genes and Proteins*, ed. M. Nei, R. K. Koehn, pp. 89–114. Sunderland, Mass: Sinauer
80. Simpson, G. G. 1944. *Tempo and Mode in Evolution*. New York: Columbia Univ. Press
81. Sneath, P. H. A., Sokal, R. R. 1973. *Numerical Taxonomy*. San Francisco: W. H. Freeman
82. Spiess, E. B. 1977. *Genes in Populations*. New York: Wiley
83. Stebbins, G. L., Ayala, F. J. 1981. Is a new evolutionary synthesis necessary? *Science* 213:967–71
84. Swift, C. C., Gilbert, C. R., Bortone, S. A., Burgess, G. H., Yerger, R. W. 1986. Zoogeography of the freshwater fishes of the southeastern United States: Savannah River to Lake Ponchartrain. In *Zoogeography of North American Freshwater Fishes*, ed. C. H. Hocutt, E. O. Wiley, pp. 213–65. New York: Wiley
85. Tajima, F. 1983. Evolutionary relationship of DNA sequences in finite populations. *Genetics* 105:437–60
86. Takahata, N. 1985. Population genetics of extranuclear genomes: A model and review. In *Population Genetics and Molecular Evolution*, ed. T. Ohta, K. Aoki, pp. 195–212. Berlin: Springer-Verlag
87. Takahata, N., Palumbi, S. R. 1985. Extranuclear differentiation and gene flow in the finite island model. *Genetics* 109:441–57
88. Takahata, N., Slatkin, M. 1984. Mitochondrial gene flow. *Proc. Natl. Acad. Sci. USA* 81:1764–67
89. Templeton, A. R. 1983. Phylogenetic inference from restriction endonuclease cleavage site maps with particular reference to the evolution of man and the apes. *Evolution* 37:221–44
90. Templeton, A. R. 1983. Convergent evolution and nonparametric inferences from restriction data and DNA sequences. In *Statistical Analysis of DNA Sequence Data*, ed. B. S. Weir, pp. 151–79. New York: Marcel Dekker
91. Uphold, W. B. 1977. Estimation of DNA sequence divergence from comparison of restriction endonuclease digests. *Nucleic Acids Res.* 4:1257–65
92. Vawter, L., Brown, W. M. 1986. Nuclear and mitochondrial DNA comparisons reveal extreme rate variation in the molecular clock. *Science* 234:194–96
93. Wainscoat, J. 1987. Out of the garden of Eden. *Nature* 325:13
94. Wallace, D. G. 1983. Structure and evolution of organelle DNAs. In *Endocytobiology*, Vol. II, ed. H. E. A. Schenk, W. Schwemmler, pp. 87–100. New York: de Gruyter
95. Whittam, T. S., Clark, A. G., Stoneking, M., Cann, R. L., Wilson, A. C. 1986. Allelic variation in human mitochondrial genes based on patterns of restriction site polymorphism. *Proc. Natl. Acad. Sci. USA* 83:9611–15
96. Wiley, E. O. 1981. *Phylogenetics*. New York: Wiley
97. Wilson, A. C., Cann, R. L., Carr, S. M., George, M. Jr., Gyllensten, U. B., Helm-Bychowski, K. M., Higuchi, R. G., Palumbi, S. R., Prager, E. M., Sage, R. D., Stoneking, M. 1985. Mitochondrial DNA and two perspectives on evolutionary genetics. *Biol. J. Linn. Soc.* 26:375–400
98. Zink, R. M., Remsen, J. V. Jr. 1986. Evolutionary processes and patterns of geographic variation in birds. In *Current Ornithology*, Vol. 4, ed. R. F. Johnston, pp. 1–69. New York: Plenum